

Polaris / Scrambler 1000

No: 2444.7423.1
Brend: Polaris
Model: Scrambler 1000
Year: 2013
Material: Al - 4 mm



Content

1. Plate 1.....	1 pc	14. Bracket.....	2 pc
2. Plate 2.....	1 pc	15. Bracket.....	2 pc
3. Plate 3.....	1 pc	16. Bracket.....	4 pc
4. Plate 4.....	1 pc	17. Bolt M6x12.....	3 pc
5. Sliders.....	2 pc	18. Bolt M6x20.....	4 pc
6. Front CV guards.....	2 pc	19. Bolt M6x30.....	3 pc
7. Rear CV guards.....	2 pc	20. Bolt M8x25.....	31 pc
8. Bracket.....	1 pc	21. Washer 6.....	2 pc
9. Insert nut M8.....	4 pc	22. Washer 8.....	16 pc
10. Insert nut M8.....	2 pc	23. Countersunk washer 6...	8 pc
11. Insert nut M8.....	2 pc	24. Countersunk washer 8...	15 pc
12. Insert nut M8.....	4 pc		
13. Bracket.....	2 pc		

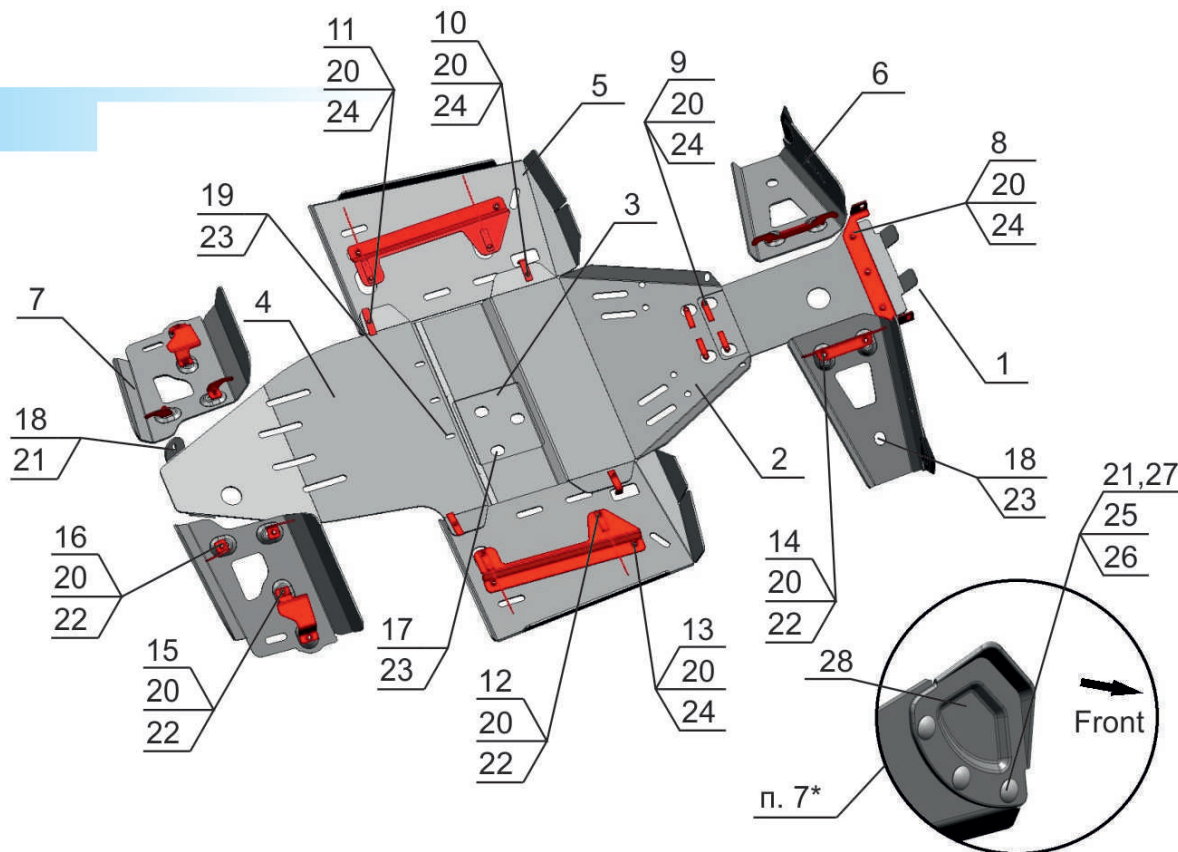

Installation Instructions

1. Put quad on its side. Remove factory guards. Screw lower fitting bolts out of factory bumper.
2. Mount bracket no.8 with original bolts screwed out of bumper. Fix plate 1 to bracket no. 8 and insert nuts no. 9 with bolts no. 20 and washers no. 24.
3. Fix plate 2 to insert nuts no. 8 with bolts no. 20 and washers no. 24.
4. Place plate 4 under plate 2 and fix it to original threaded apertures with bolts no. 18, 19 and washers no. 21, 23.
5. Fix plate no. 3 to original threaded apertures with bolts no. 17 and washers no. 23.

6. Mount brackets no. 13 to insert nuts no.12 with bolts no. 20 and washers no. 22. Fix sides of sliders no. 5 to bracket no.13 with bolts no. 20 and washers no. 24. Fix sliders no. 5 to insert nuts no.10,11 with bolts no. 20 and washers no. 24.
7. Mount front CV guards to brackets no.14 and to original threaded apertures with bolts no.18, 20 and washers no. 22, 23.
8. Mount rear CV guards to brackets no. 15,16 with bolts no. 20 and washers no. 22.
9. Tighten all screws.

TOOLS REQUIRED



S-10, S-13



S-4, S-5

SCREW FORCE



M6-10 Nm



M8-30 Nm



M10-50 Nm

FRONT ARM GUARDS

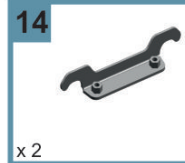

Bolt M8x25 - 4 pc
Bolt M6x20 - 2 pc
Washer 8 - 4 pc
Countersunk washer 6 - 2 pc

REAR ARM GUARDS

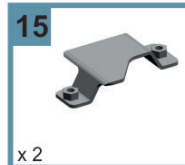
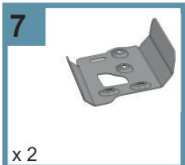

Bolt M8x25 - 8 pc
Washer 8 - 8 pc

FRONT REDUCER GUARD

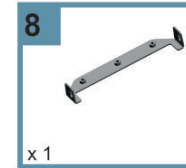
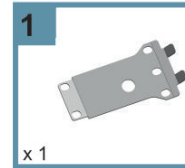

Bolt M8x25 - 5 pc
Countersunk washer 8 - 5 pc
9.Insert nut M8 - 2 pc

ENGINE BLOCK GUARD

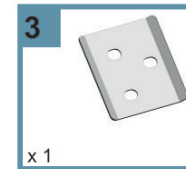
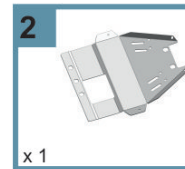

Bolt M6x12 - 3 pc
Bolt M6x30 - 3 pc
Bolt M8x25 - 2 pc
Countersunk washer 6 - 6 pc
Countersunk washer 8 - 2 pc
9.Insert nut M8 - 2 pc

BACK REDUCER GUARD

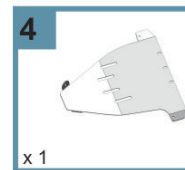

Bolt M6x20 - 2 pc
Washer 6 - 2 pc

SIDE GUARD

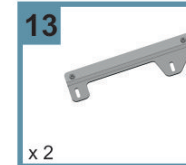
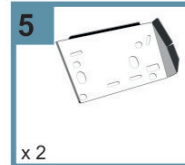

Bolt M8x25 - 12 pc
Washer 8 - 4 pc
Countersunk washer 8 - 8 pc
10.Insert nut M8 - 2 pc
11.Insert nut M8 - 2 pc
12.Insert nut M8 - 4 pc